

# Fundamentos para HTTP

Yuri Vasilevski

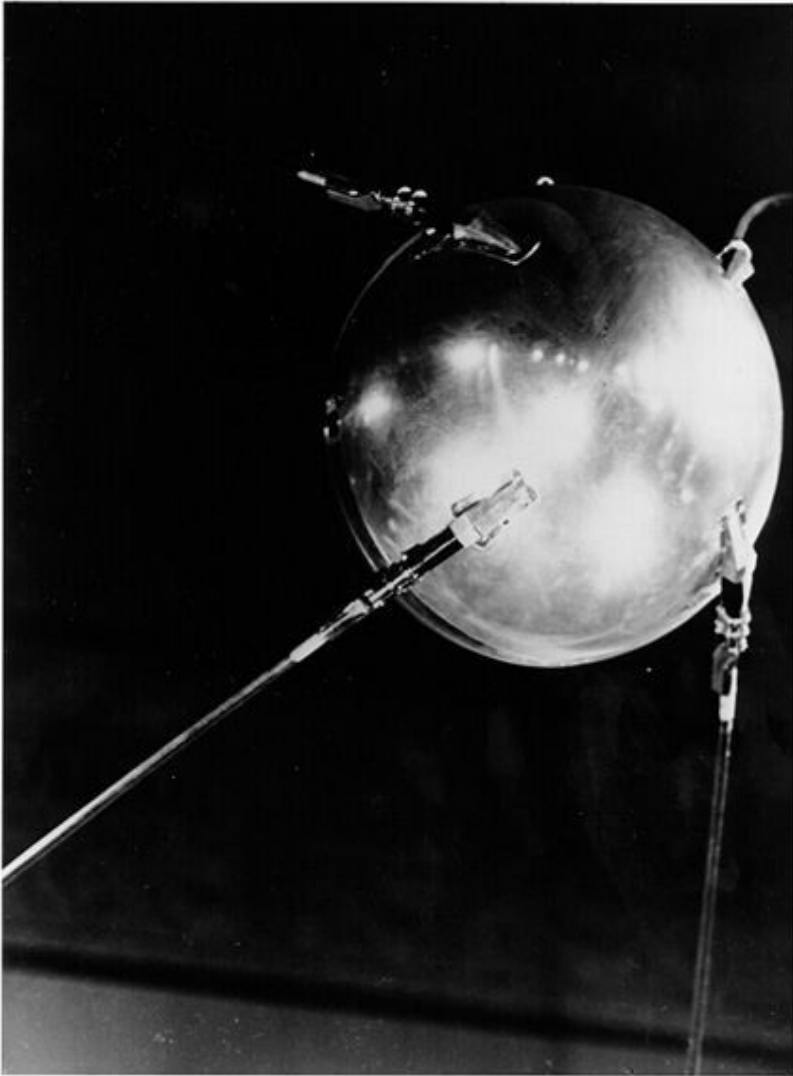

Oct 1957 Спутник 1

Nov 1957 Спутник 2

Feb 1958 Advanced Research  
Projects Agency (ARPA)

Jul 1958 National Aeronautics and  
Space Administration  
(NASA)

Nov 1969 ARPANET

1972 ARPA - DARPA

1993 DARPA - ARPA

1996 ARPA - DARPA

# ARPANET

1969 - 1990

- Packet Switching Network (56kbps)
- Network Control Program (NCP)

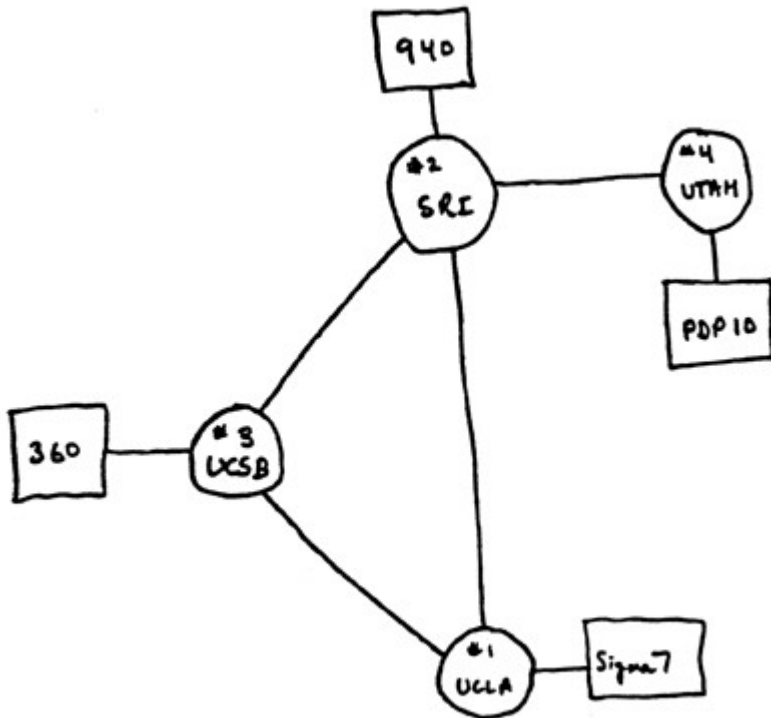

- 1971 TELNET (RFC 854)
- 1971 FTP (RFC 959)
- 1972 e-mail UUCP (RFC 976)
- 1974 TCP
- 1978 TCP/IP
- 1979 USENET UUCP
- 1980 UDP (RFC 768)
- 1981 IP (RFC 791)
- 1981 RCP (RFC 793)
- 1981 BSD implementa TCP/IP**
- 1982 SMTP (RFC 2821)
- 1983 ARPANET cambia a TCP/IP**
- 1984 DNS (RFC 1035)
- 1986 NSFNET**
- 1990 ARPANET se disuelve

# ARPANET

1969 - 1990

- Packet Switching Network (56kbps)
- Network Control Program (NCP)

- 1971 TELNET (RFC 854)
- 1971 FTP (RFC 959)
- 1972 e-mail UUCP (RFC 976)
- 1974 TCP
- 1978 TCP/IP
- 1979 USENET UUCP
- 1980 UDP (RFC 768)
- 1981 IP (RFC 791)
- 1981 RCP (RFC 793)
- 1981 BSD implementa TCP/IP
- 1982 SMTP (RFC 2821)
- 1983 ARPANET cambia a TCP/IP
- 1984 DNS (RFC 1035)
- 1986 NSFNET
- 1990 ARPANET se disuelve

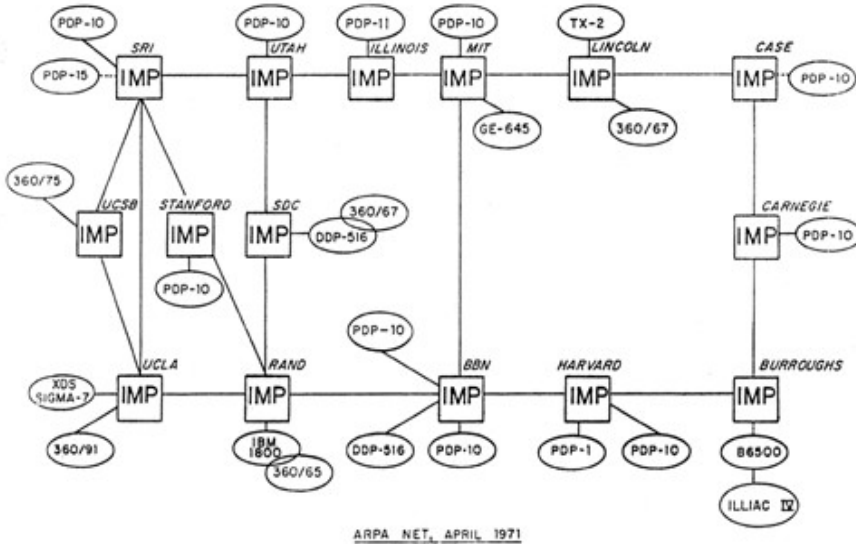

# ARPANET

1969 - 1990

- Packet Switching Network (56kbps)
- Network Control Program (NCP)

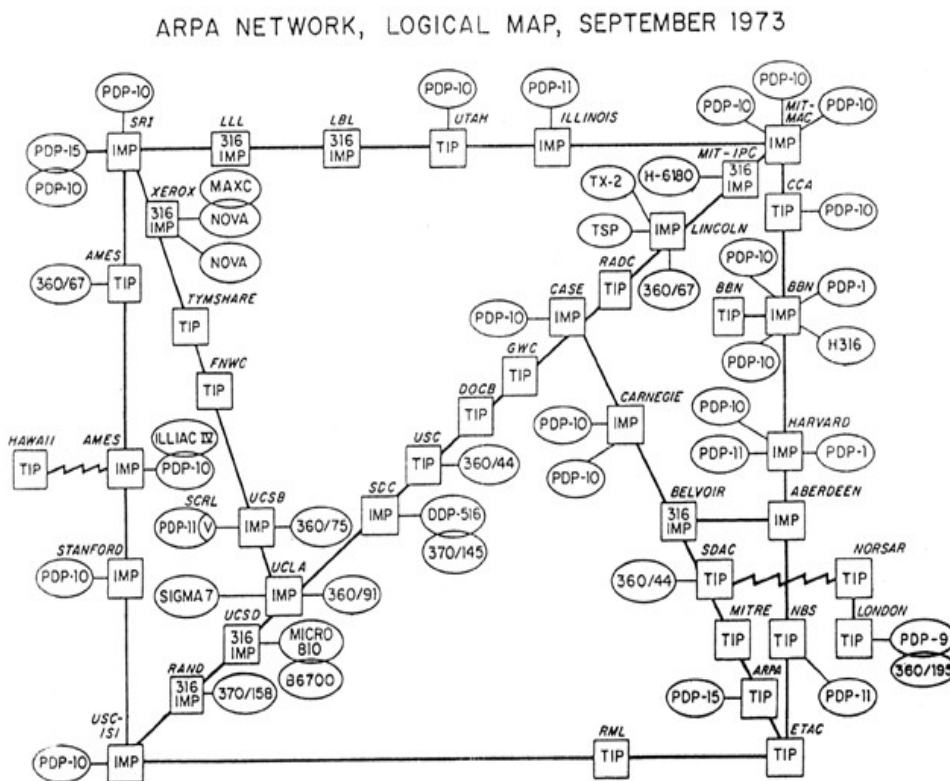

- 1971 TELNET (RFC 854)
- 1971 FTP (RFC 959)
- 1972 e-mail UUCP (RFC 976)
- 1974 TCP
- 1978 TCP/IP
- 1979 USENET UUCP
- 1980 UDP (RFC 768)
- 1981 IP (RFC 791)
- 1981 RCP (RFC 793)
- 1981 BSD implementa TCP/IP
- 1982 SMTP (RFC 2821)
- 1983 ARPANET cambia a TCP/IP
- 1984 DNS (RFC 1035)
- 1986 NSFNET
- 1990 ARPANET se disuelve

# ARPANET

1969 - 1990

- Packet Switching Network (56kbps)
- Network Control Program (NCP)

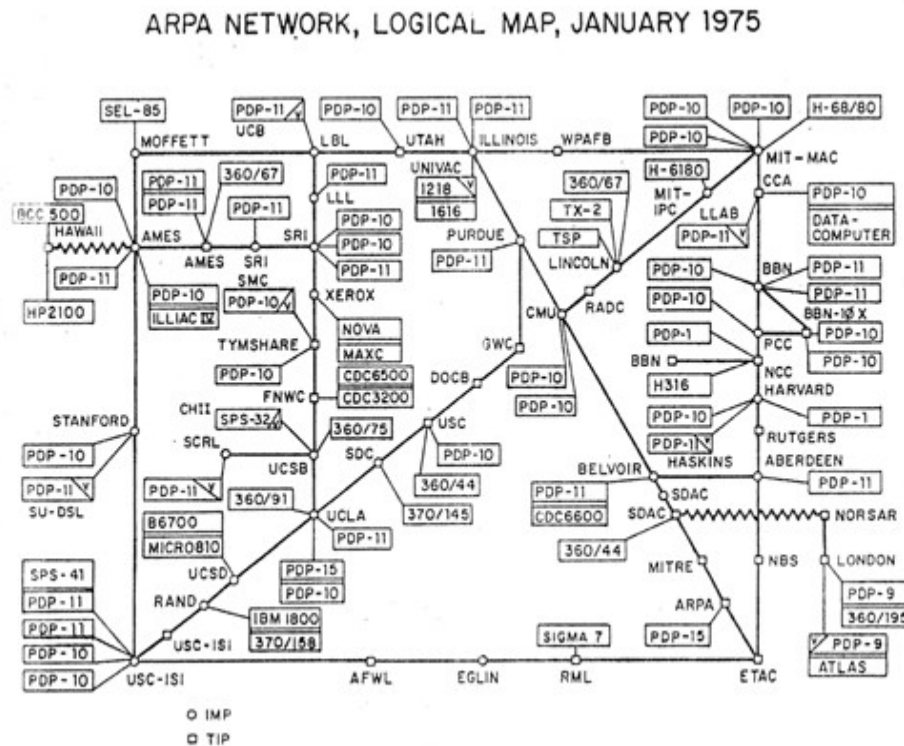

- 1971 TELNET (RFC 854)
- 1971 FTP (RFC 959)
- 1972 e-mail UUCP (RFC 976)
- 1974 TCP
- 1978 TCP/IP
- 1979 USENET UUCP
- 1980 UDP (RFC 768)
- 1981 IP (RFC 791)
- 1981 RCP (RFC 793)
- 1981 BSD implementa TCP/IP
- 1982 SMTP (RFC 2821)
- 1983 ARPANET cambia a TCP/IP
- 1984 DNS (RFC 1035)
- 1986 NSFNET
- 1990 ARPANET se disuelve

# ARPANET

1969 - 1990

- Packet Switching Network (56kbps)
- Network Control Program (NCP)

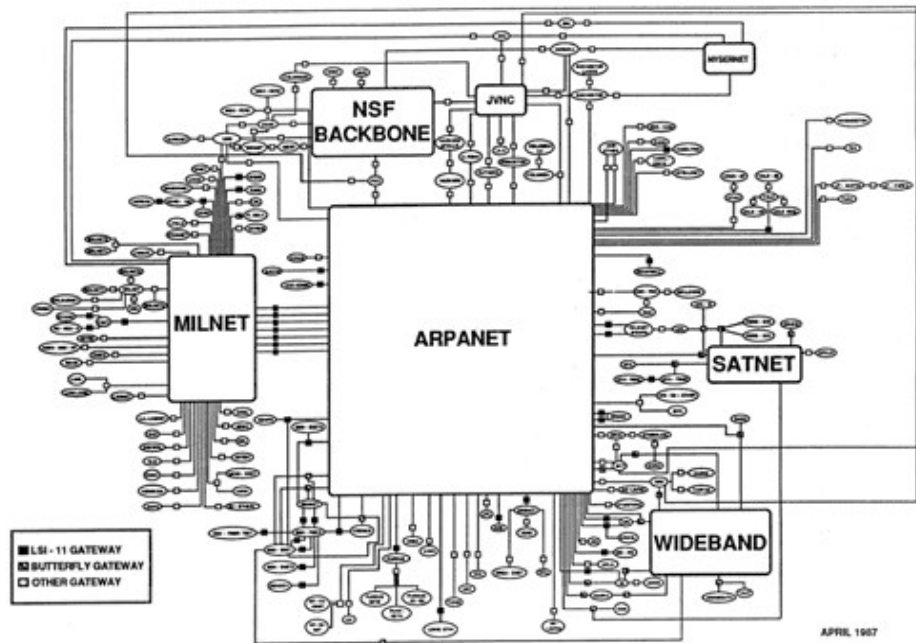

BBN Communications Corporation

- 1971 TELNET (RFC 854)
- 1971 FTP (RFC 959)
- 1972 e-mail UUCP (RFC 976)
- 1974 TCP
- 1978 TCP/IP
- 1979 USENET UUCP
- 1980 UDP (RFC 768)
- 1981 IP (RFC 791)
- 1981 RCP (RFC 793)
- 1981 BSD implementa TCP/IP
- 1982 SMTP (RFC 2821)
- 1983 ARPANET cambia a TCP/IP
- 1984 DNS (RFC 1035)
- 1986 NSFNET
- 1990 ARPANET se disuelve

- Packet Switching Network (56kbps)
- Internet Protocol (IP)

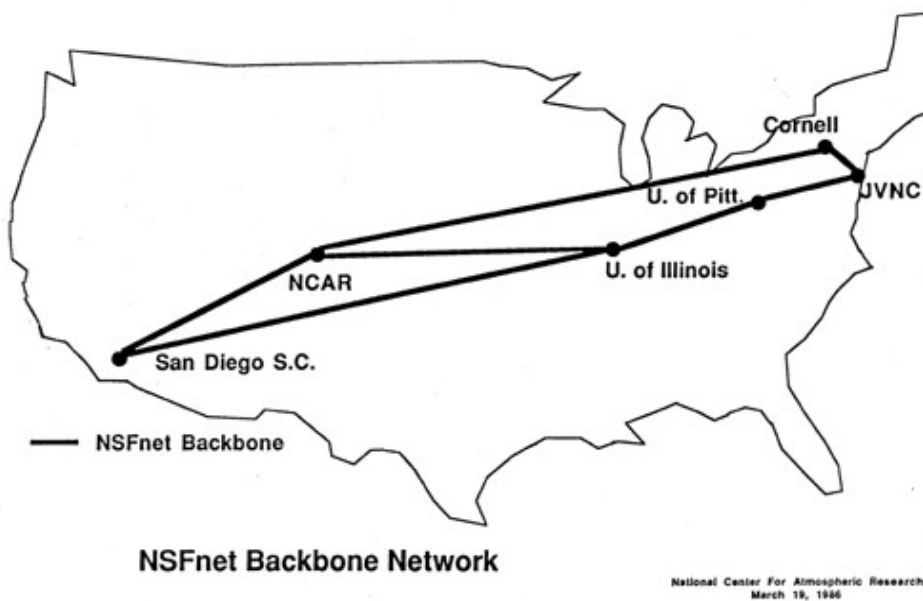

- 1986 NNTP (RFC 977)
- 1988 Backbone cambia a T1  
Ruteo Regional
- 1988 ca dk fi fr is no se
- 1988 IRC (RFC 1459)
- 1989 au de il it jp mx nl nz uk
- 1989 T3 (45 mbps)
- 1990 Gopher (RFC 1436)
- 1990 Primer ISP "The World"
- 1991 100 Paises
- 1991 HTTP (RFC 2616)
- 1993 Mosaic
- 1993 NAPs
- 1995 NSFNET se disuelve



# NSFNET

1986 - 1995

- Packet Switching Network (56kbps)
- Internet Protocol (IP)

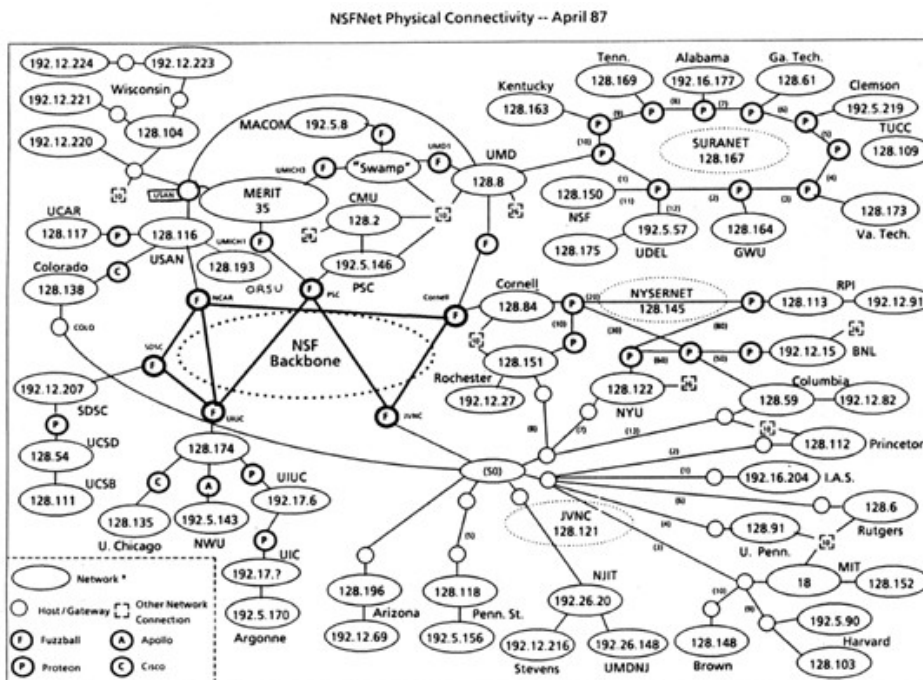

- 1986 NNTP (RFC 977)
- 1988 Backbone cambia a T1 Ruteo Regional
- 1988 ca dk fi fr is no se
- 1988 IRC (RFC 1459)
- 1989 au de il it jp mx nl nz uk
- 1989 T3 (45 mbps)
- 1990 Gopher (RFC 1436)
- 1990 Primer ISP "The World"
- 1991 100 Paises
- 1991 HTTP (RFC 2616)
- 1993 Mosaic
- 1993 NAPs
- 1995 NSFNET se disuelve

\* For some networks internal structure (e.g. subnets) is suppressed.

- Packet Switching Network (56kbps)
- Internet Protocol (IP)

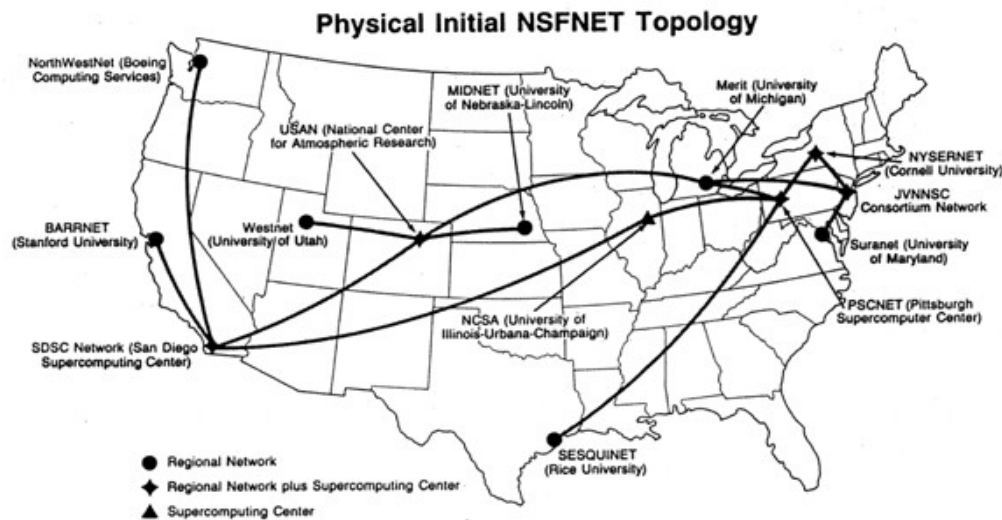

Center for Cartographic Research and Spatial Analysis, Michigan State University, 2/88

- 1986 NNTP (RFC 977)
- 1988 Backbone cambia a T1
- Ruteo Regional
- 1988 ca dk fi fr is no se
- 1988 IRC (RFC 1459)
- 1989 au de il it jp mx nl nz uk
- 1989 T3 (45 mbps)
- 1990 Gopher (RFC 1436)
- 1990 Primer ISP "The World"
- 1991 100 Paises
- 1991 HTTP (RFC 2616)
- 1993 Mosaic
- 1993 NAPs
- 1995 NSFNET se disuelve

- Packet Switching Network (56kbps)
- Internet Protocol (IP)

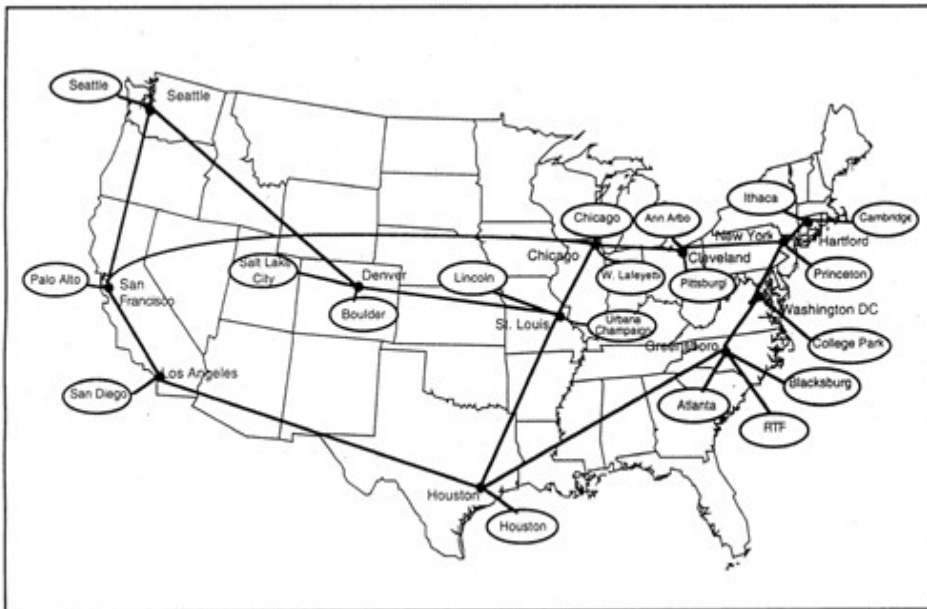

- 1986 NNTP (RFC 977)
- 1988 Backbone cambia a T1
- Ruteo Regional
- 1988 ca dk fi fr is no se
- 1988 IRC (RFC 1459)
- 1989 au de il it jp mx nl nz uk
- 1989 T3 (45 mbps)
- 1990 Gopher (RFC 1436)
- 1990 Primer ISP "The World"
- 1991 100 Paises
- 1991 HTTP (RFC 2616)
- 1993 Mosaic
- 1993 NAPs
- 1995 NSFNET se disuelve

# Network Access Points (NAPs)

1993 - ????

Niveles:

- NAP
- Backbones Nacionales
- ISPs Regionales
- ISPs Locales
- Redes Comerciales

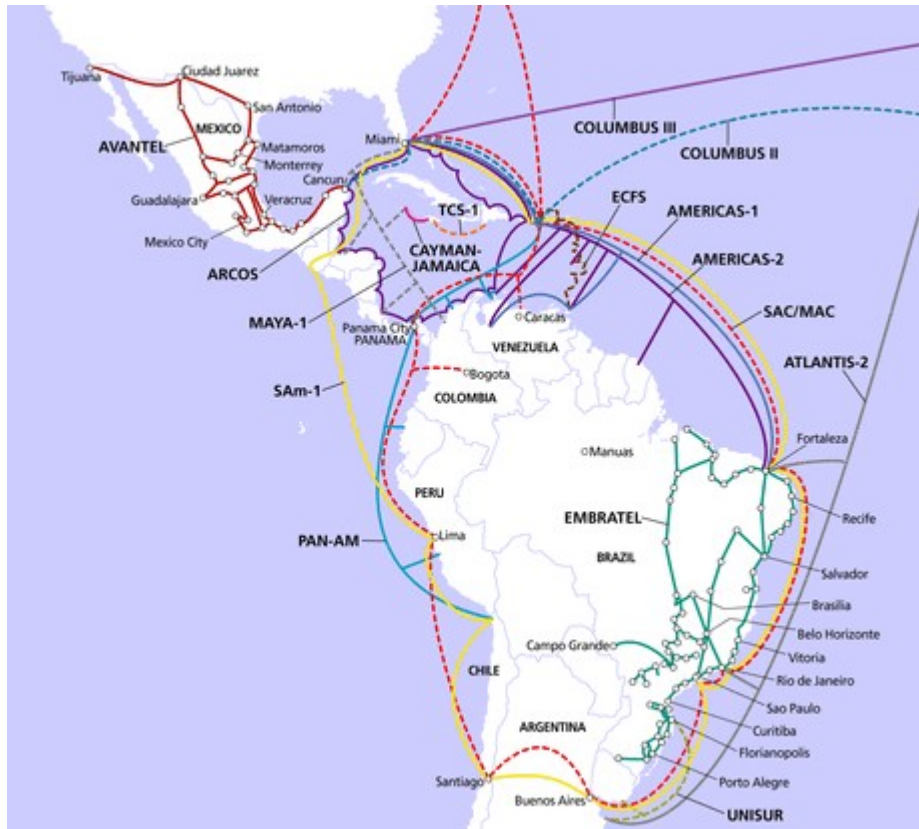

TCP/IP

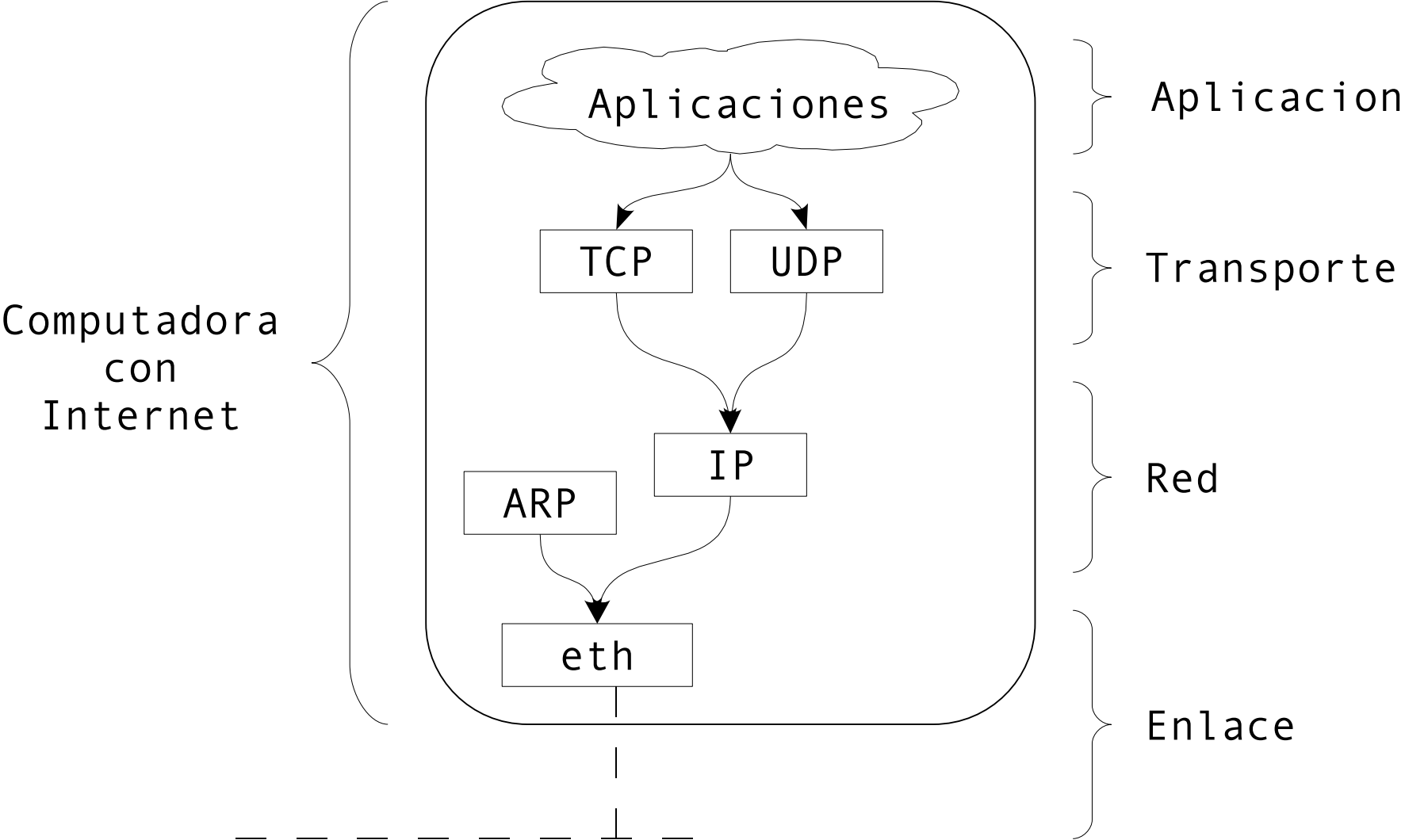

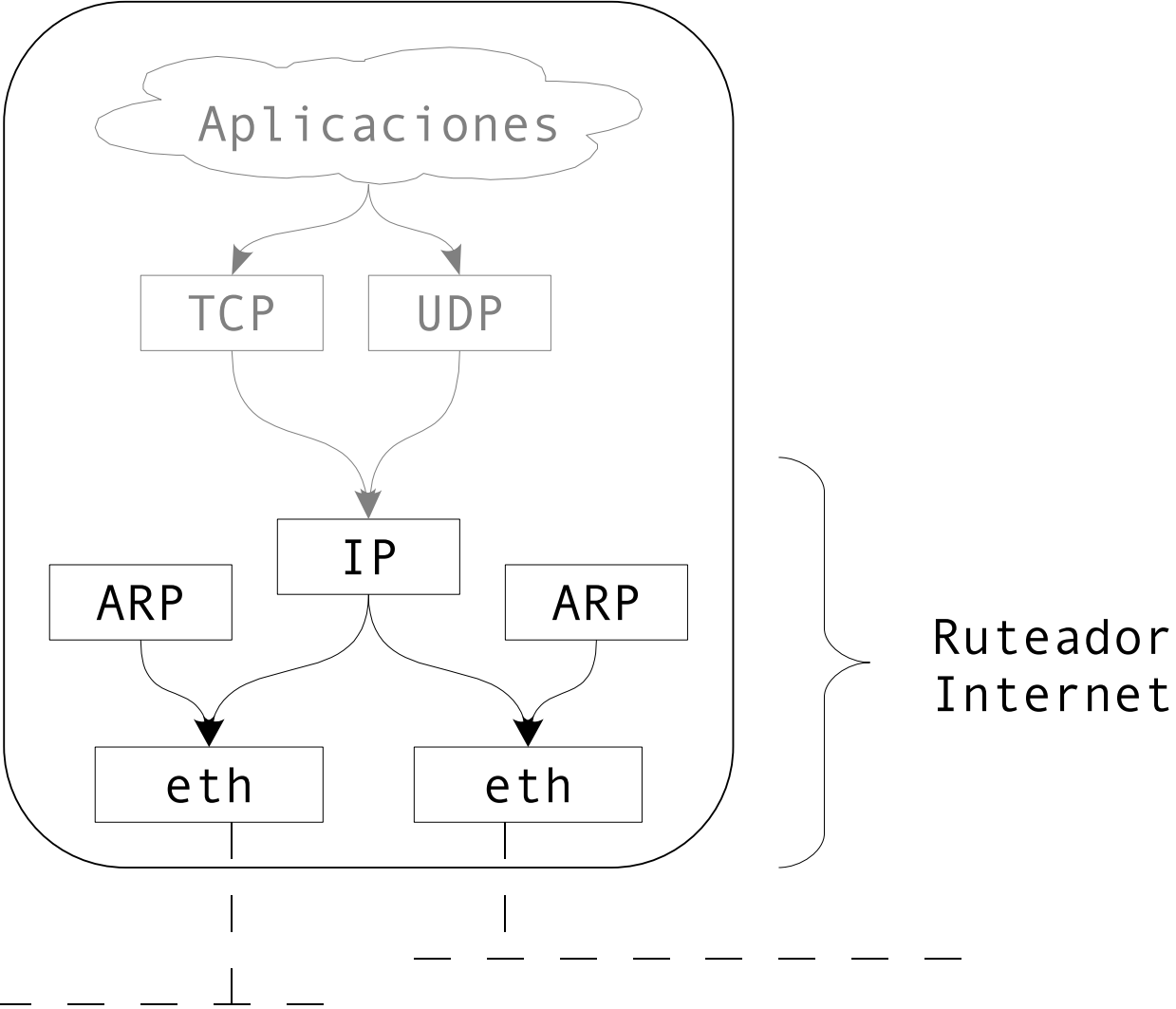

- 6 bytes: Direccion del Destino
- 6 bytes: Direccion del Origen
- 2 bytes: Tipo del Mensaje
- 2 bytes: Longitud del Mensaje
- 38 a 1492 bytes: Mensaje
- 4 bytes: CRC

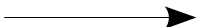
00:00:00:00:00:00            FF:FF:FF:FF:FF:FF



---

Address	Hwaddress
192.168.1.101	00:0F:66:7D:5B:DB
192.168.1.1	00:0C:41:9C:7A:51
192.168.1.5	00:0D:0B:7A:A4:88
192.168.1.11	00:03:2D:04:1D:8E

---

Origen : 192.168.1.101      00:0C:41:9C:7A:51  
Destino: 192.168.1.5

Origen : 192.168.1.5        00:0D:0B:7A:A4:88  
Destino: 192.168.1.101    00:0C:41:9C:7A:51

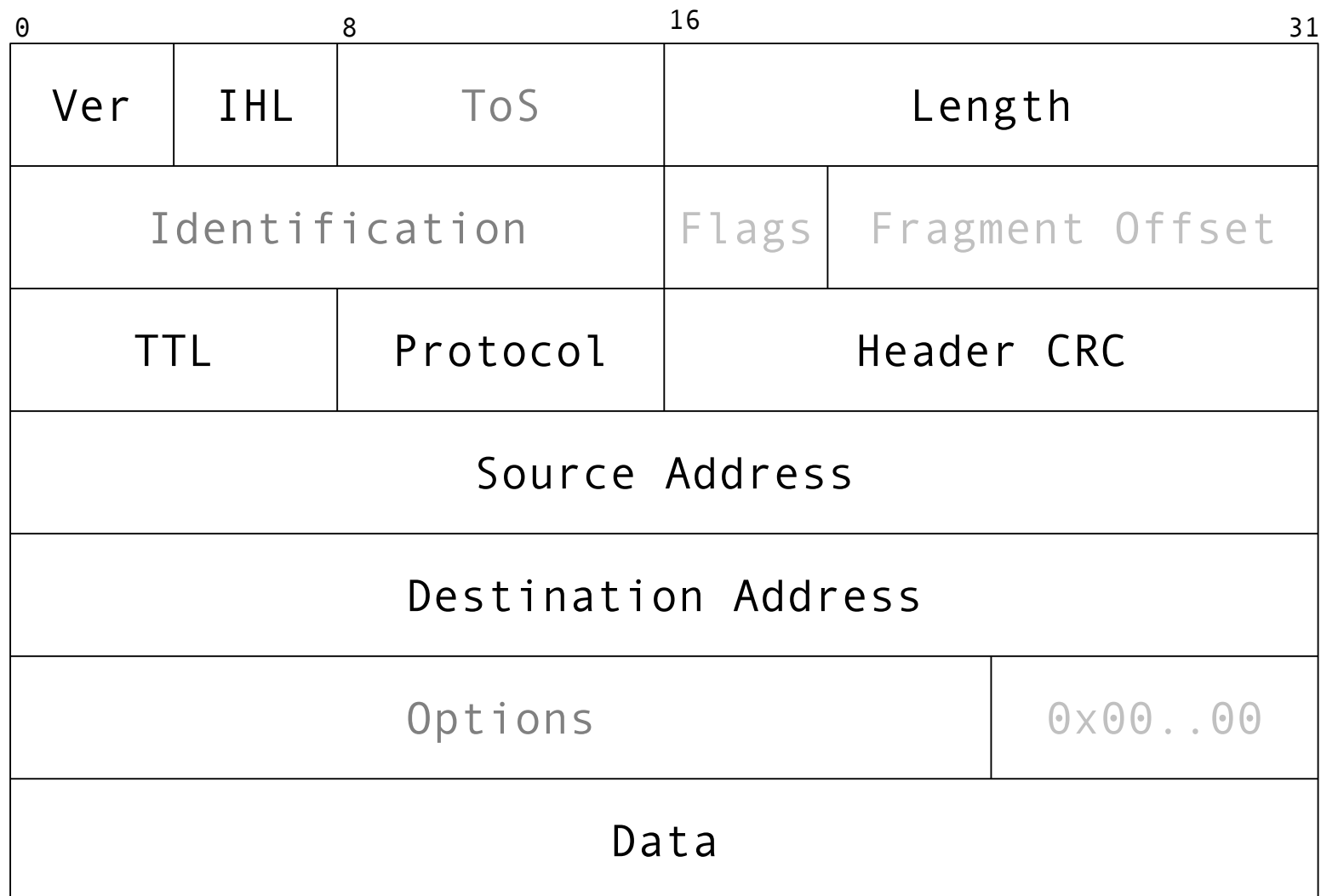

---

Destination	Gateway	Genmask	Iface
192.168.2.5	0.0.0.0	255.255.255.255	tun0
192.168.22.0	0.0.0.0	255.255.255.0	intel0
172.16.176.0	0.0.0.0	255.255.255.0	vmnet8
192.168.1.0	192.168.2.5	255.255.255.0	tun0
192.168.1.0	0.0.0.0	255.255.255.0	3com0
192.168.133.0	0.0.0.0	255.255.255.0	3com0
148.247.186.0	0.0.0.0	255.255.255.0	intel0
148.247.14.0	0.0.0.0	255.255.255.0	intel0
127.0.0.0	127.0.0.1	255.0.0.0	lo
0.0.0.0	148.247.14.128	0.0.0.0	intel0

---

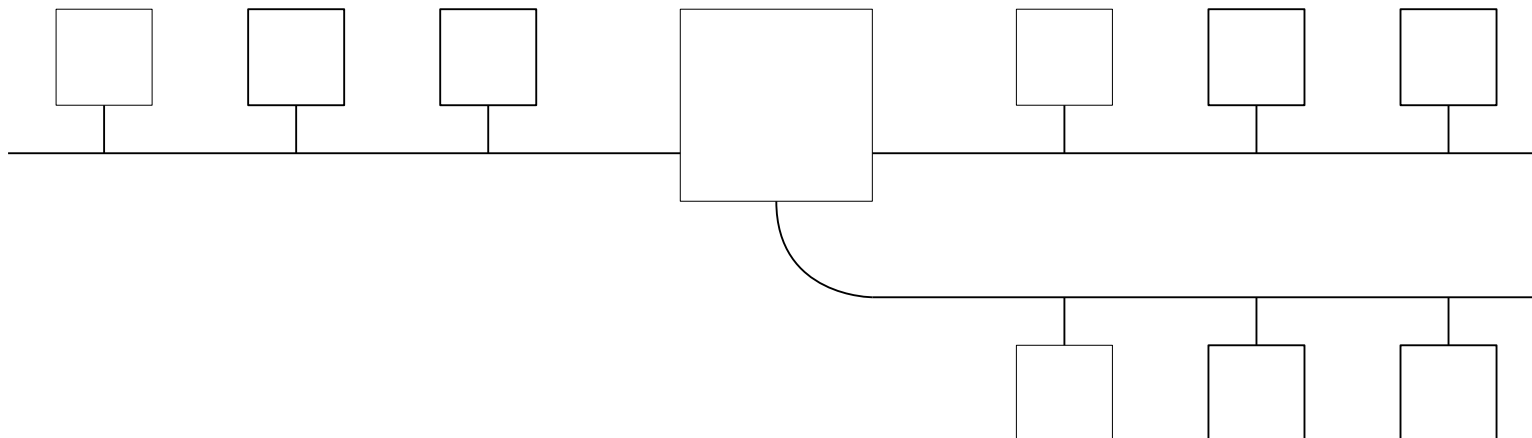

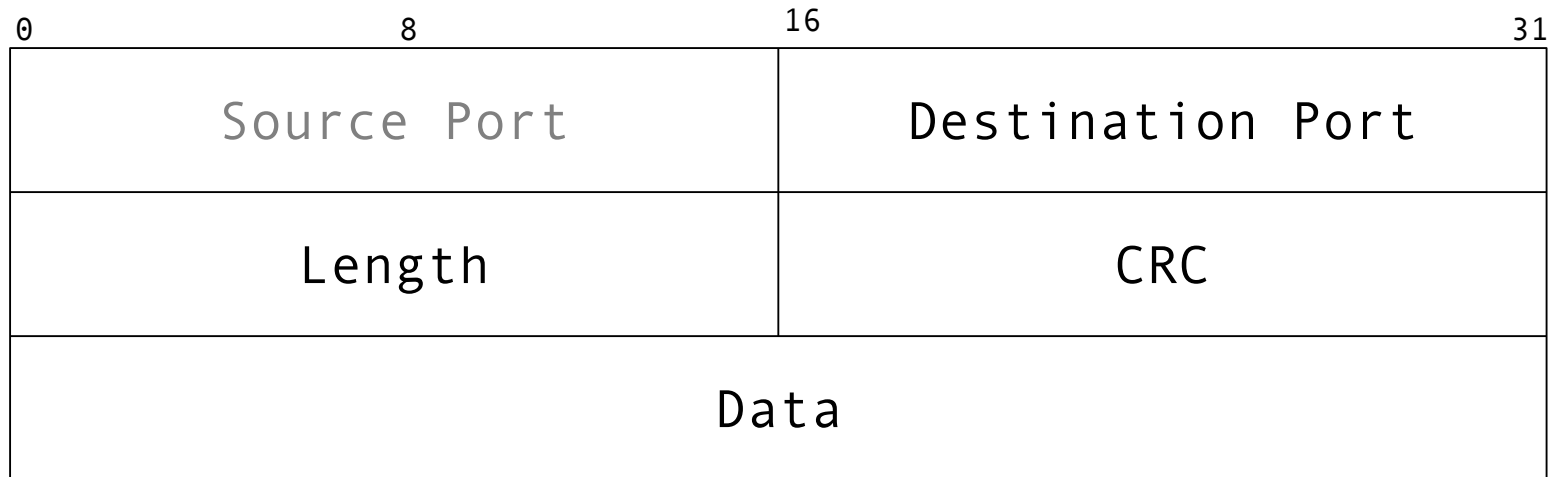

- Sin Coneccion
- Orientado a Datagramas

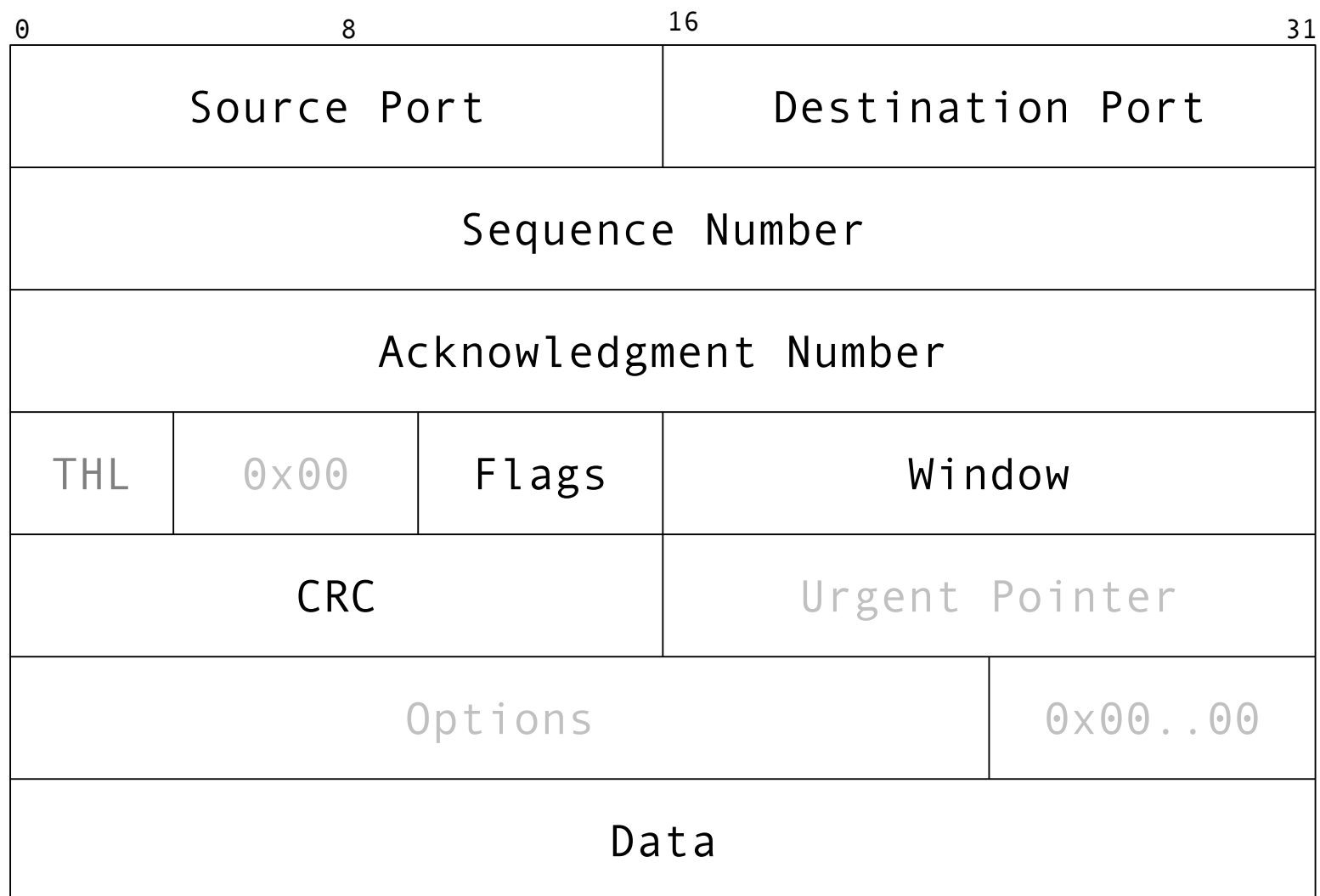

- Con Coneccion
- Orientado a Streams
- Correccion y Recuperacion de Errores

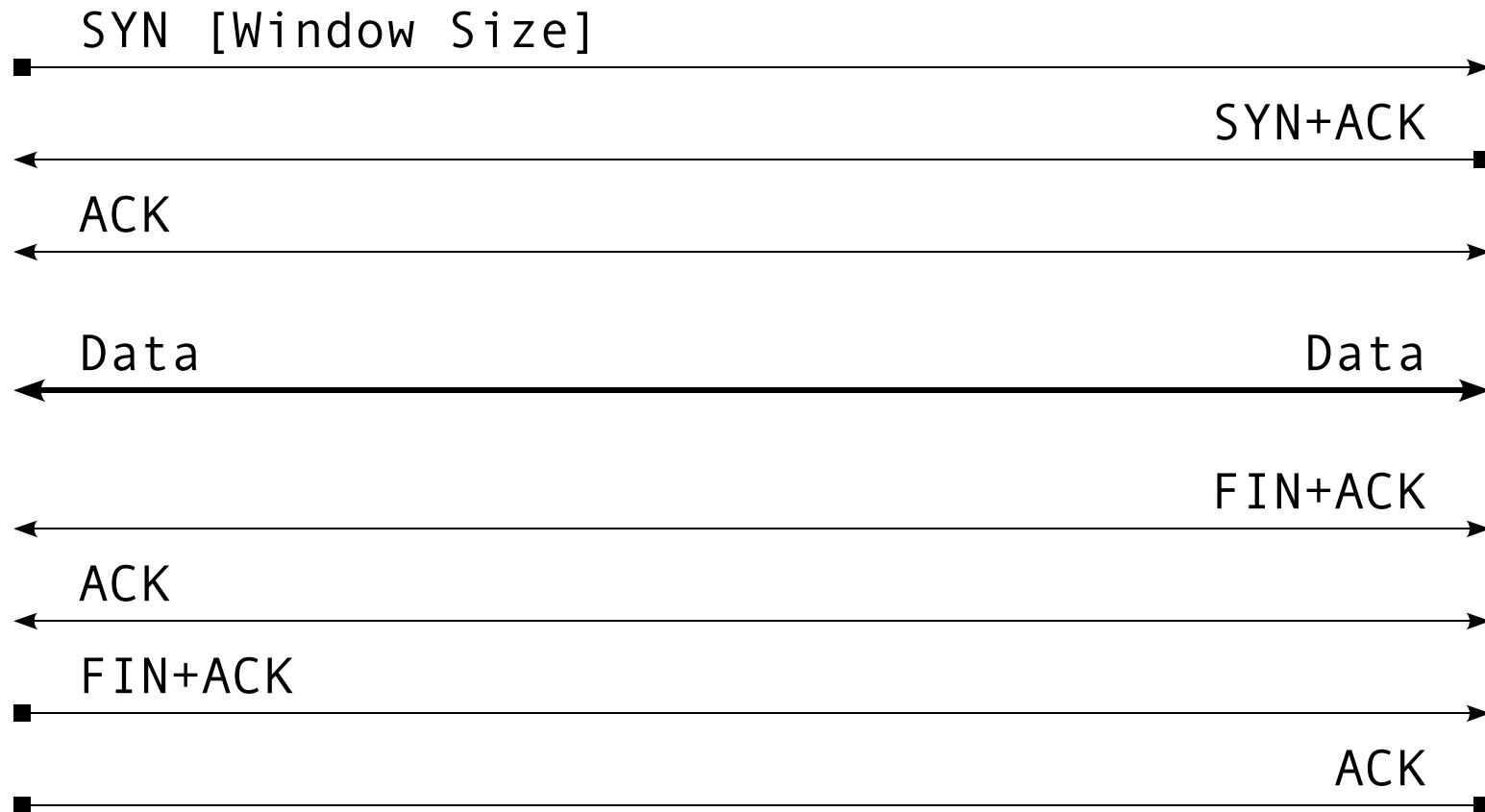

UDP	TCP
Datagram Velocidad Latencia	Stream Reliable Longevidad

- Con Coneccion
  - Orientado a Streams
  - Correccion y Recuperacion de Errores
  - Autenticacion [Fuerte]
  - Compresion y Cifrado
- 

#### Sesion TLS:

- ID
- Peer Certificate
- Compression Method
- Cipher spec
- Master Secret
- Resumable



``Conceptually, HTTP/TLS is very simple.  
Simply use HTTP over TLS precisely as  
you would use HTTP over TCP.``

Preguntas?